











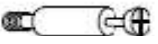

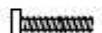

Y003



 X2  30 min	 A $\phi 6 \times 36 \text{MM}$ x6	 B $\phi 15 \times 10 \text{MM}$ x6	 C $\phi 7.8 \times 30 \text{MM}$ x20	 D $M7 \times 50 \text{MM}$ x6	 E $M6 \times 55 \text{MM}$ x10	 F $M8 \times 38 \text{MM}$ x8	 G $\phi 16 \times \phi 8 \times 2$ x8
	 H $\phi 16 \times \phi 6.5 \times 1$ x8	 I $\phi 5 \times 16 \text{MM}$ x8	 J $M3.5 \times 14 \text{MM}$ x32	 K $M4$ x1	 M x4	 N $15 \times 10 \text{MM}$ x8	 O $M6 \times 20 \text{MM}$ x16

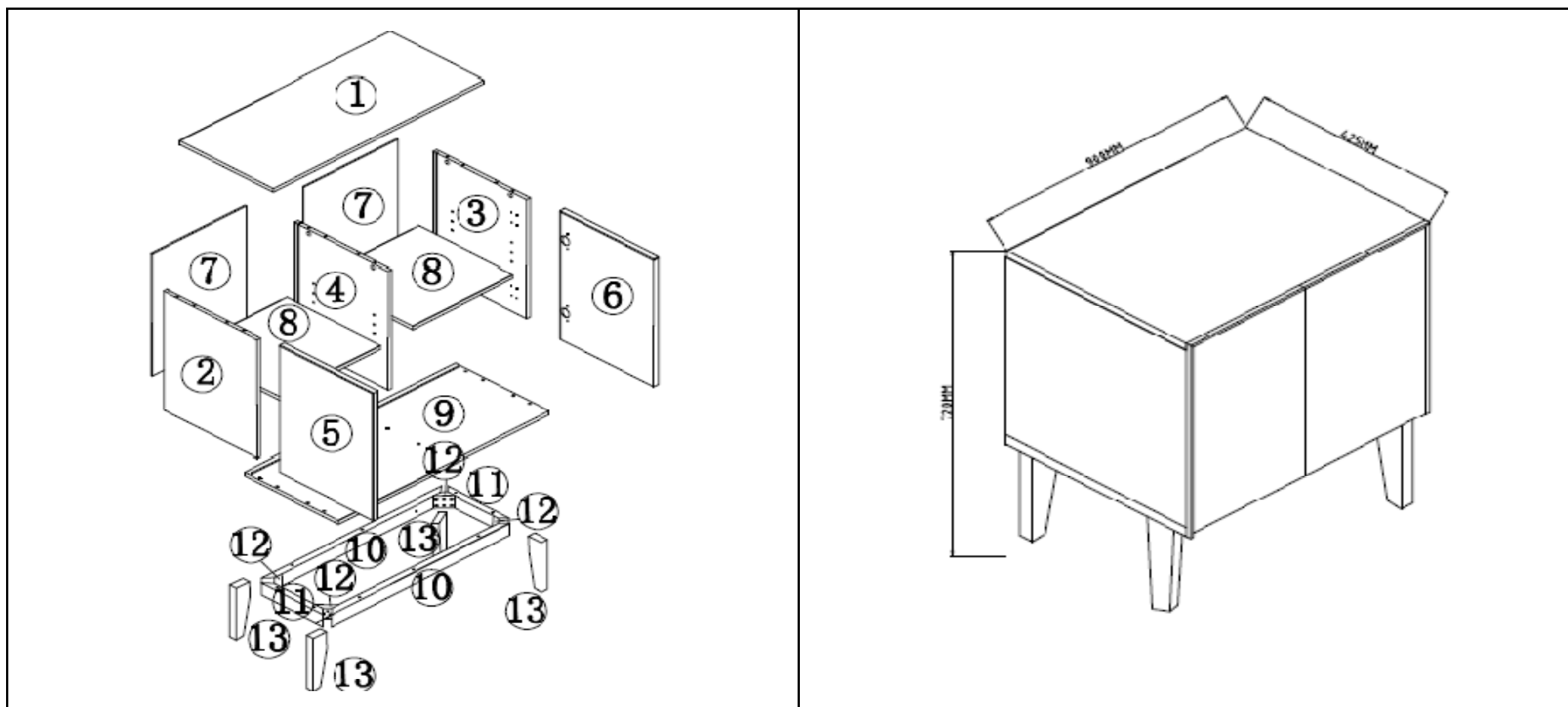

Y003

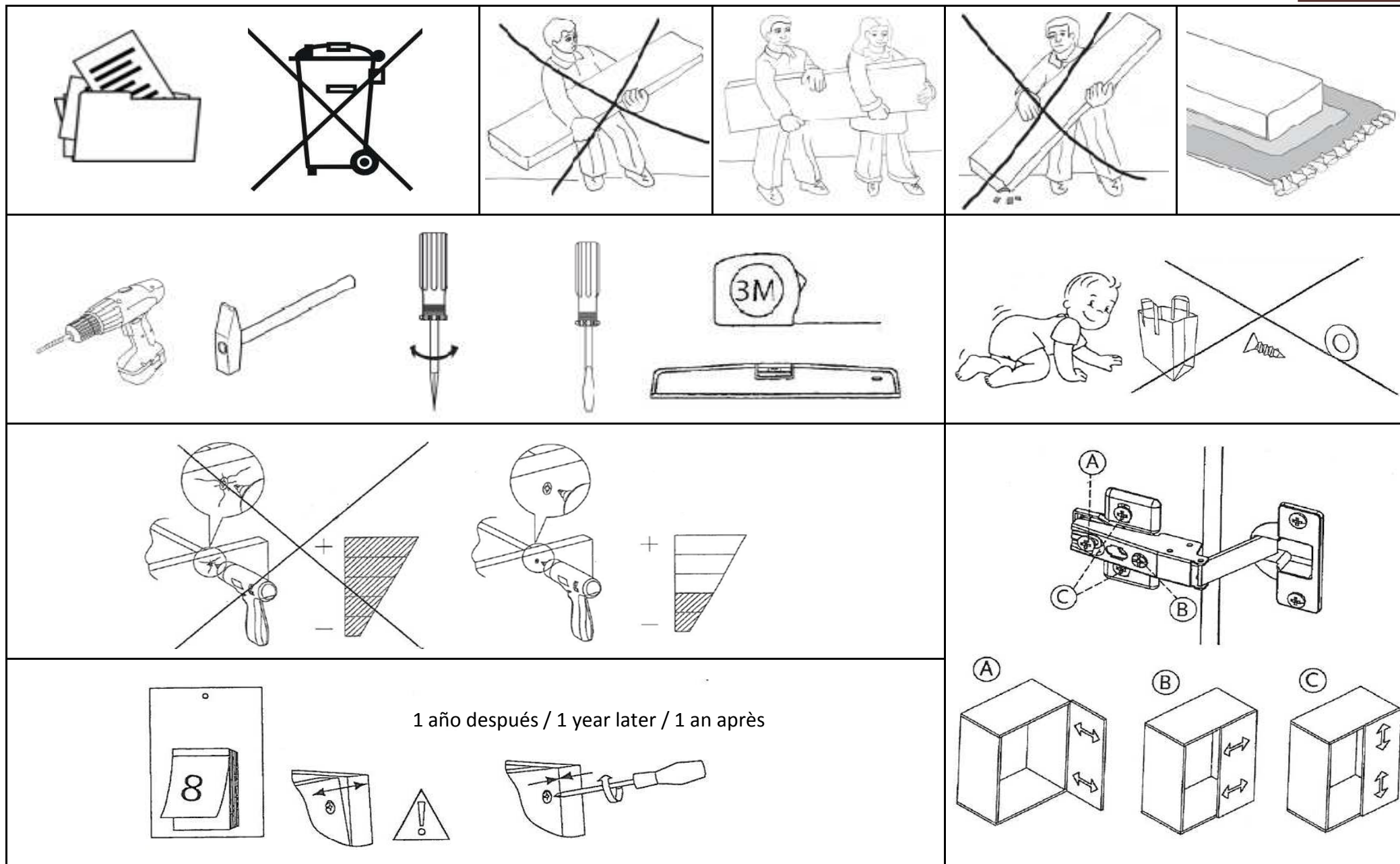

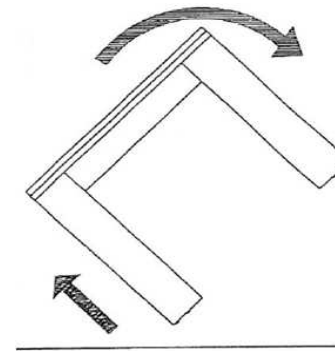
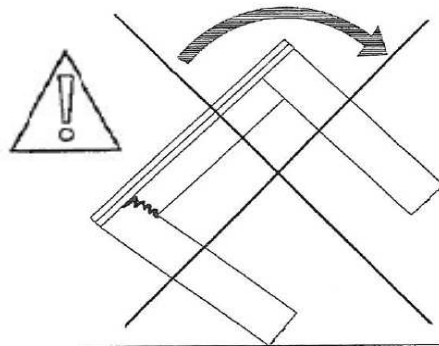
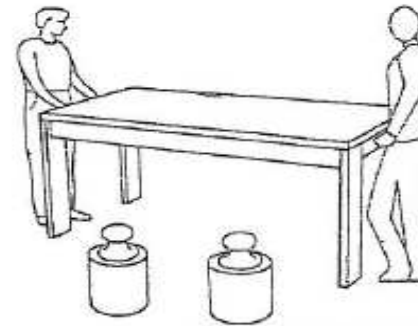
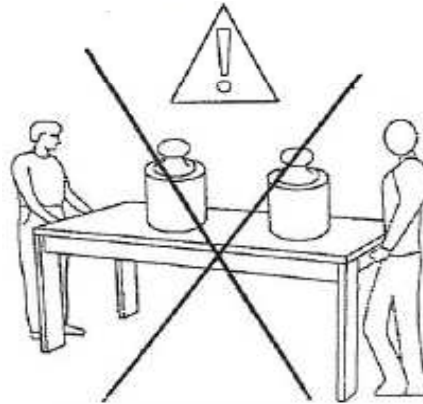
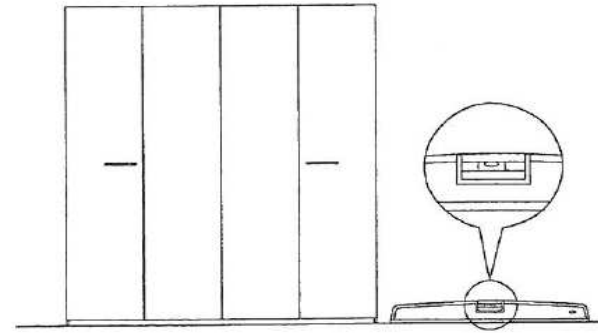
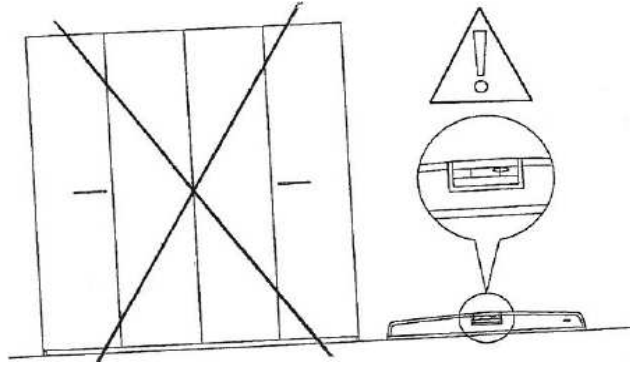

Y003

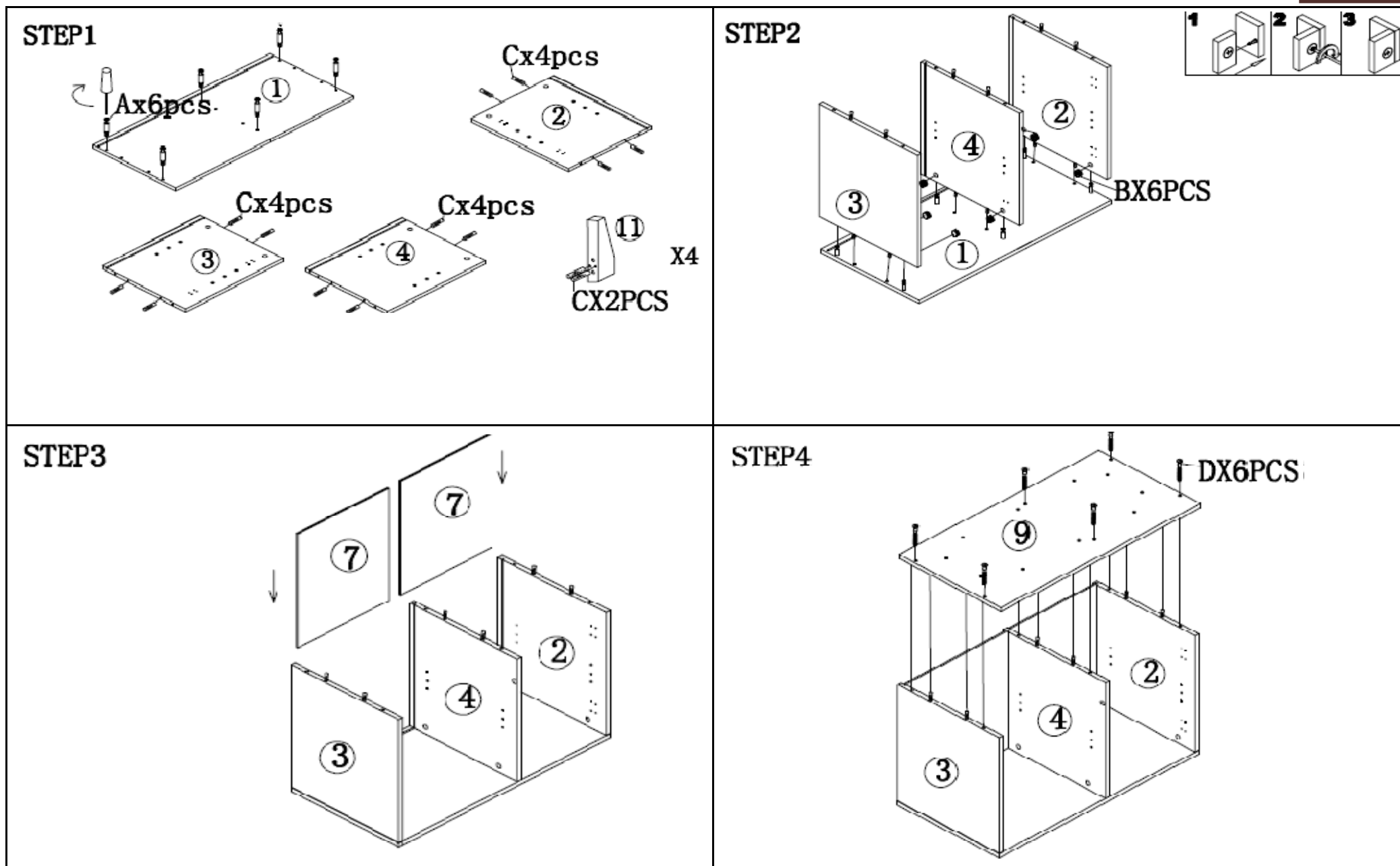

Y003

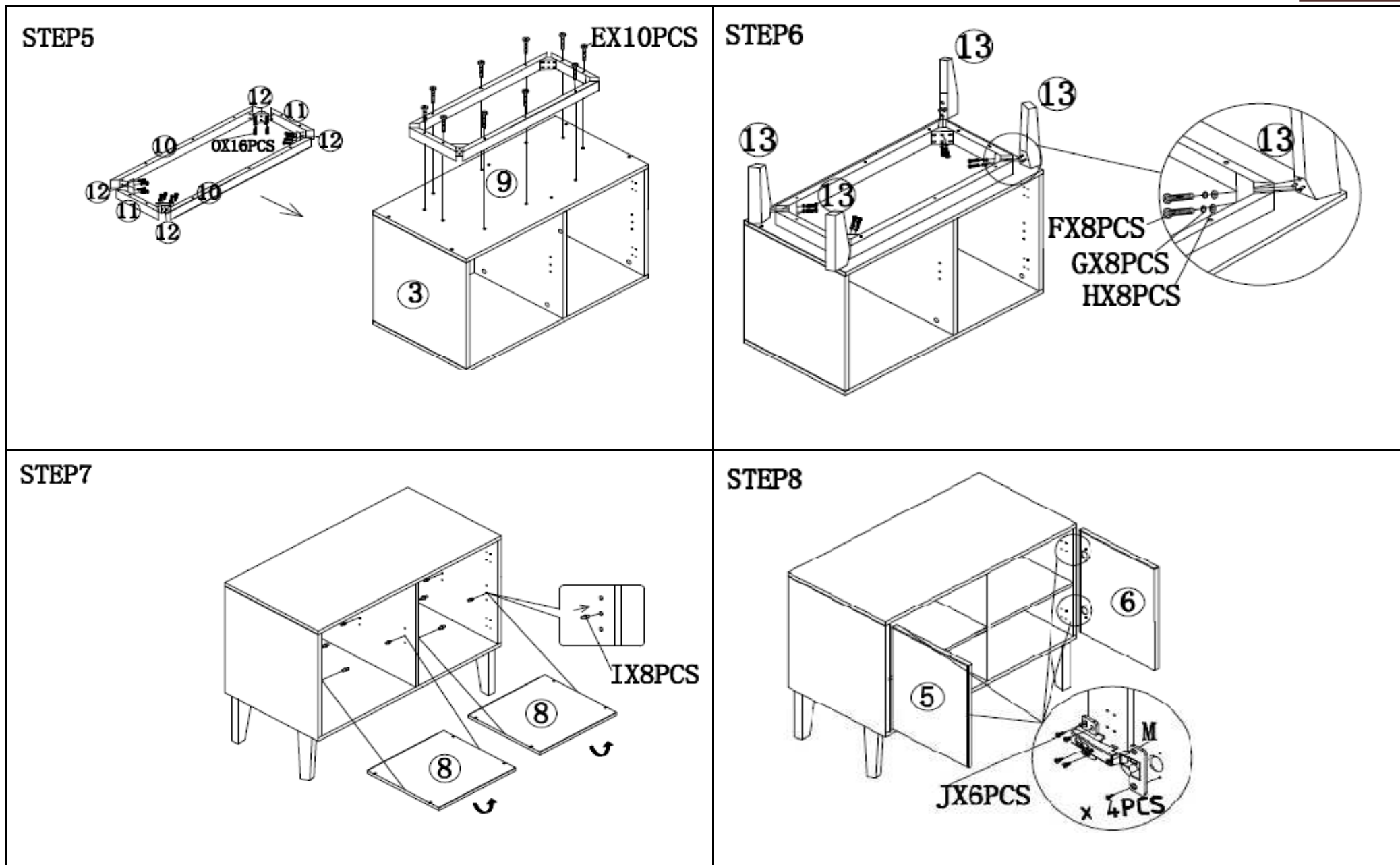



STEP9

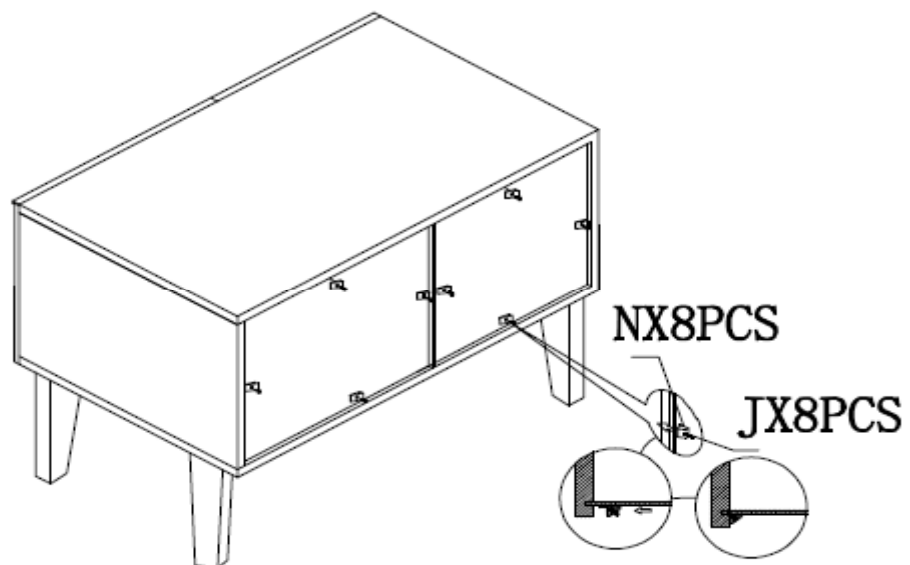

STEP10

