

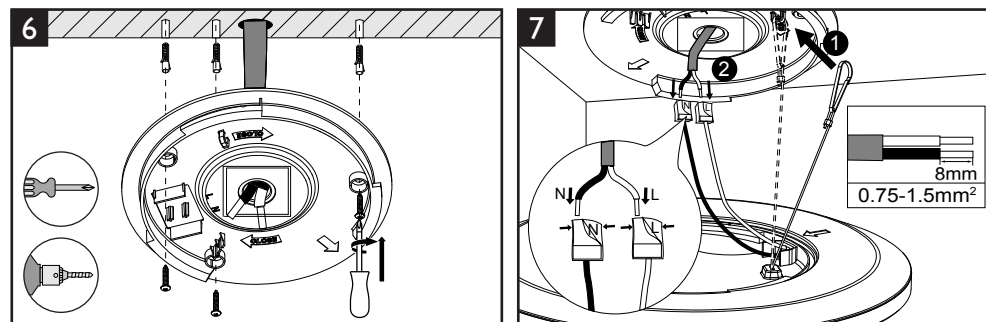

# PHILIPS

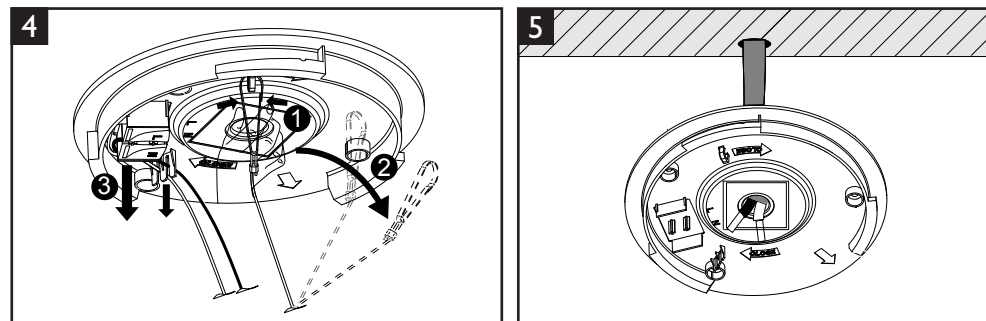

# PHILIPS

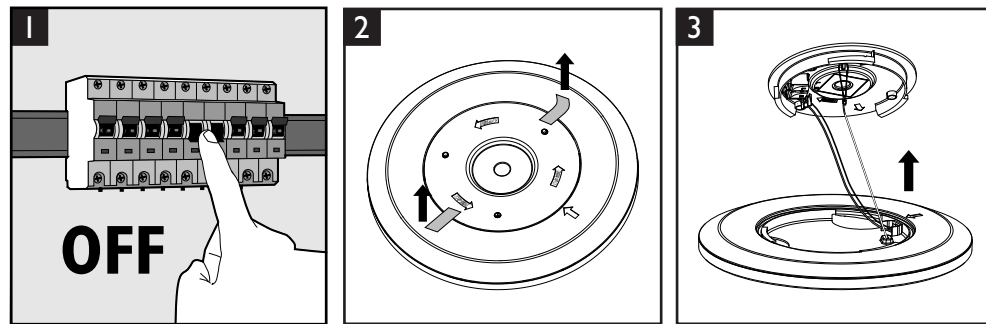
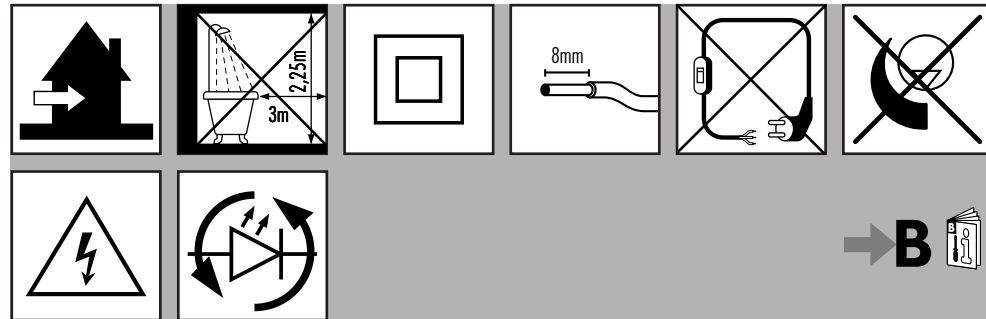
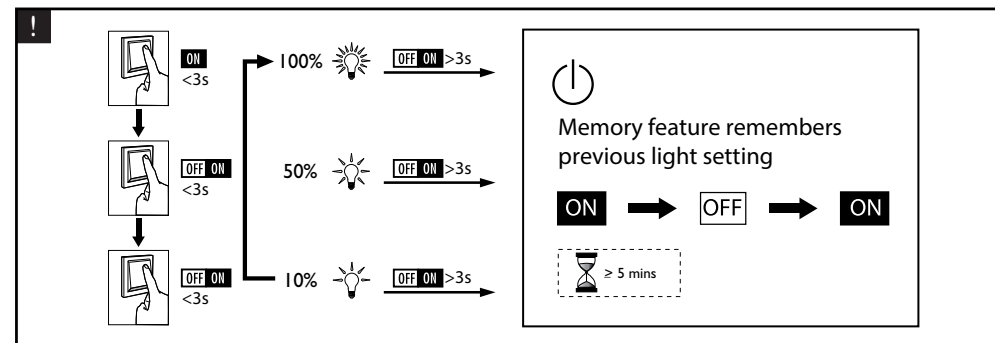
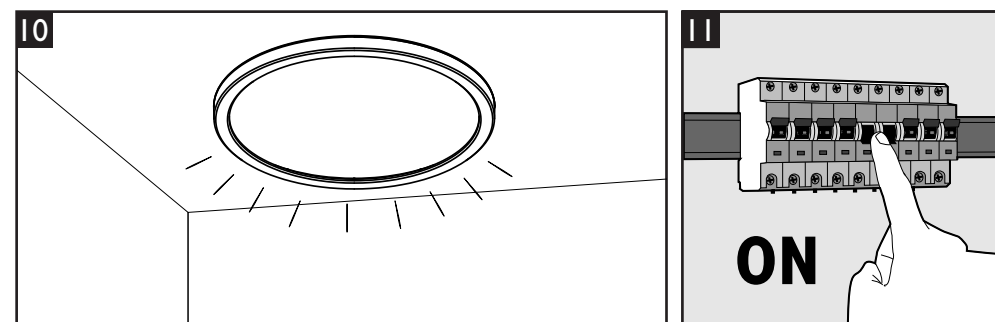
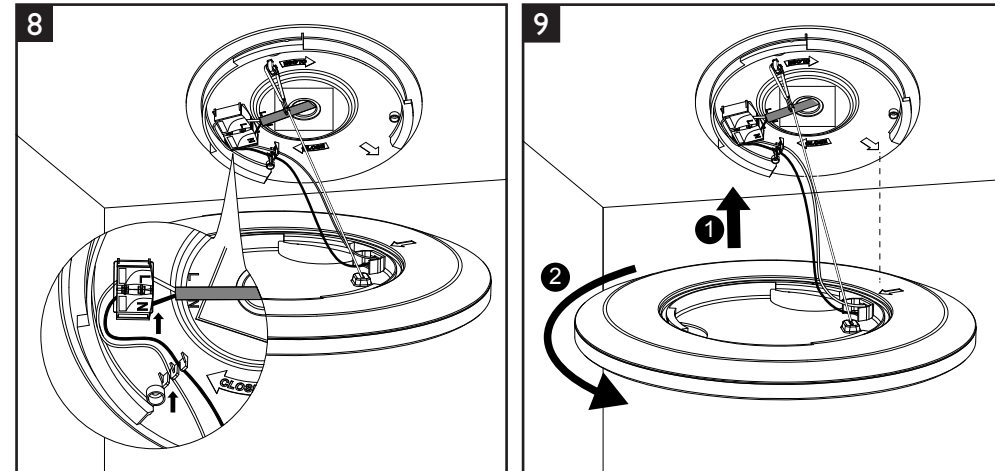

Signify  
 I.B.R.S. / C.C.R.I. Numéro 10461  
 5600 VB Eindhoven, the Netherlands  
[www.philips.com/lighting](http://www.philips.com/lighting)  
 © 2018 Signify Holding

324165391731  
 Last update: 18/03/19